

# ENR Dead Front Interlocked Circuit Breaking Receptacles

ENP Plugs General Purpose  
Ark•Gard® 2; Factory Sealed

Cl. I, Div. 1 & 2, Groups B†,C,D  
Cl. II, Div. 1 & 2, Groups F,G  
Cl. III  
NEMA 3,7BCD,9FG,12

Explosionproof  
Dust-Ignitionproof  
Raintight  
Wet Locations

2P

## Application:

- ENR receptacles and ENP plugs are used:
- with portable electrical equipment such as compressors, tools, lighting systems, and similar devices
  - in areas made hazardous by the presence of flammable vapors and gases or combustible dusts
  - wherever portable electrical equipment is likely to be transferred from hazardous to nonhazardous areas
  - in damp and corrosive areas
  - when power requirements do not exceed 20 amperes
  - where general purpose application is required

## Features:

- Ark•Gard 2 receptacle incorporates three spring-loaded slide keys that prevent the receptacle face plate from being rotated until the ENP plug is fully inserted into the receptacle. To make the connection, the ENP plug is fully inserted; and the receptacle face moved inward by pushing the plug forward (Fig. 1). The plug is then rotated, (Fig. 2), closing the circuit. As rotation begins, the plug becomes locked in the receptacle and cannot be accidentally disengaged. In making or breaking the circuit, any resulting electrical arc is confined in the factory-sealed chamber.
- Factory-sealed chamber encloses the potential arcing components between two explosion-proof threaded joints. These threads are specially coated to guarantee freedom of movement, which ensures on-off action. No additional seals are required.
- One piece molded gasket seals cover plate and ENP plug when plug is inserted, providing full environmental protection at the receptacle face.
- Top-hinged cover design with 45° downward angle provides superior protection in damp, wet, and dirty locations.
- Molded-in contact design provides superior interior contact reliability.
- ENP plugs can be used in nonhazardous areas with standard U-ground NEMA/EEMAC configuration 5 and 6 receptacles, eliminating the need for two separately equipped portable units of the same type. The ENR receptacle will not accept standard NEMA/EEMAC configuration plugs.
- ENP plug handle body is designed with an internal cord strain relief mechanism and a cable sealing grommet which will accept various cable diameters.
- Field assembly is accomplished with standard tools.
- Use standard EDS back boxes.

† Single gang receptacles purchased as a complete assembly with EDS back box are suitable for Class I, Group B usage. Two gang receptacles can be modified for Class I, Group B usage. Add the letter B to Cat. No. Example: ENRB22201. Seals must be installed within 1½" of each conduit opening. Receptacle units only (ie. ENR5201) are not suitable for Class I, Group B.



Figure 1

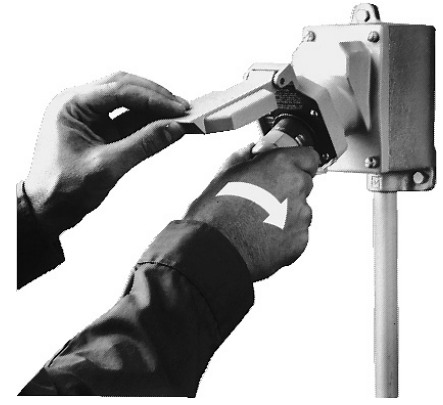

Figure 2

## Grounding:

- NEC Article 501 and CEC Section 18 requires that metal frames or exposed non-current-carrying metal parts of portable devices used in hazardous locations be grounded through an extra conductor in the portable cord. ENR receptacles and ENP plugs are provided with an extra grounding pole.

## Standard Materials:

- Receptacle housing, spring door and plug body – die cast copper-free aluminum
- Interiors: receptacle – Krydon® fiberglass-reinforced polyester material; plugs – nylon 100
- Contacts: receptacle blade – brass; receptacle switch – silver; plug – brass
- Receptacle cover hinge pin and spring – stainless steel
- Receptacle gasket – neoprene
- Plug bushing – neoprene

## Standard Finishes:

- Copper-free aluminum – aluminum acrylic paint
- Brass – natural

## Electrical Rating Ranges:

- Receptacles – 20 amperes; 125 vac and 250 vac, 50-400 hertz
- Plugs – 15 amperes; 125 vac and 250 vac, 50-400 hertz  
20 amperes; 125 vac and 250 vac, 50-400 hertz

## Certifications and Complies:

- NEC:  
Class I, Division 1 and 2, Groups B†,C,D  
Class II, Division 1 and 2, Groups F,G  
Class III
- ANSI/UL Standard 1010
- NEMA/EEMAC 3,7BCD,9FG
- CEC:  
Class I, Division 1 and 2, Groups B, C, D  
Class II, Division 1 and 2, Group G  
Class III

**CAUTION:** To reduce the risk of ignition of hazardous atmospheres, do not use plugs or receptacles in Class II, Group F locations that contain electrically conductive dusts.

## Dimensions

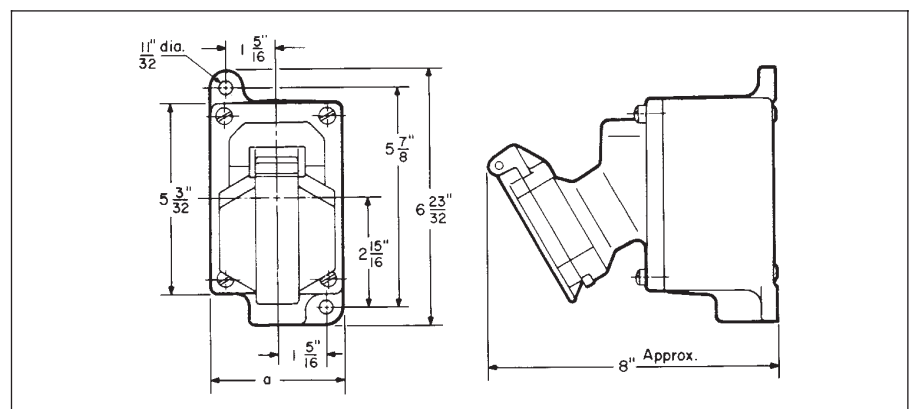

a=3½ for single gang; 7¼ for two gang.

**2P**

# ENR Dead Front Interlocked Circuit Breaking Receptacles

ENP Plugs General Purpose (For US NEC Applications); ArkGard® 2; Factory Sealed

Cl. I, Div. 1 & 2, Groups B\*,C,D Explosionproof  
 Cl. II, Div. 1 & 2, Groups F,G Raintight  
 Cl. III Wet Locations  
 NEMA 3,7BCD,9FG,12 Dust-Ignitionproof

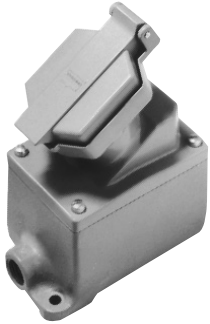

ENR single gang dead end assembly



ENR single gang dead end assembly with spring door open

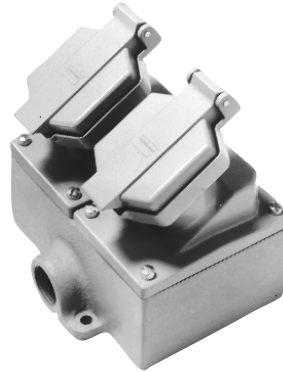

ENR two gang dead end assembly

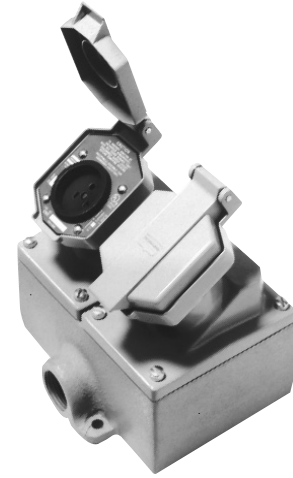

ENR two gang dead end assembly with one spring door open

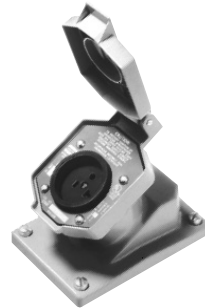

ENR receptacle only, with spring door open



ENP plug

Receptacle Rating	Description	Hub Size	Single Gang Receptacle Assembly Cat. # ‡	Two Gang Receptacle Assembly Cat. # ‡	Receptacle Unit Only Cat. #	NEMA Config.	15 Amp Plug Cat. #	NEMA Config.	20 Amp Plug Cat. #	NEMA Config.
20 amp, 125 volt	Dead End	1/2	ENR11201	ENR12201	ENR5201		ENP5151		ENP5201	
		3/4	ENR21201	ENR22201						
		1	ENR31201	ENR32201						
	Through Feed	1/2	ENRC11201	ENRC12201						
		3/4	ENRC21201	ENRC22201						
		1	ENRC31201	ENRC32201						
20 amp, 250 volt	Dead End	1/2	ENR11202	ENR12202	ENR6202		ENP6152		ENP6202	
		3/4	ENR21202	ENR22202						
		1	ENR31202	ENR32202						
	Through Feed	1/2	ENRC11202	ENRC12202						
		3/4	ENRC21202	ENRC22202						
		1	ENRC31202	ENRC32202						

\* Single gang receptacles purchased as a complete assembly with EDS back box are suitable for Class I, Group B usage. Two gang receptacles can be modified for Class I, Group B usage. Add the letter B to Cat. No. Example: ENRB22201. Seals must be installed within 1 1/2" of each conduit opening. Receptacle units only (ie. ENR5201) are not suitable for Class I, Group B.

‡ With Feraloy® Iron Alloy EDS, EDSC back boxes.

Heavy Duty Plugs and Receptacles



# ENR Dead Front Interlocked Circuit Breaking Receptacles

ENP Plugs; General Purpose (For CEC Applications) ArkGard® 2; Factory Sealed

Cl. I, Div. 1 & 2, Groups B\*,C,D  
Cl. II, Div. 1 & 2, Group G  
Cl. III  
EFC 3,7BCD,9G,12

Explosionproof  
Raintight  
Wet Locations  
Dust-Ignitionproof

**2P**

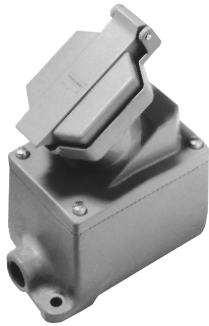

ENR single gang dead end assembly



ENR single gang dead end assembly with spring door open

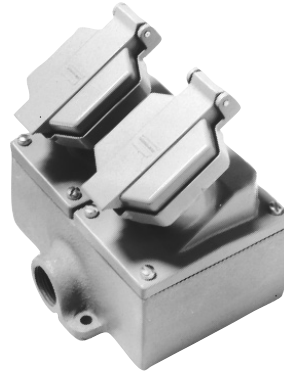

ENR two gang dead end assembly



ENR two gang dead end assembly with one spring door open

Receptacle Rating	Description	Hub Size	Single Gang Receptacle Assembly Cat. # ‡	Two Gang Receptacle Assembly Cat. # ‡	Receptacle Unit Only Cat. #	EEMAC Config.	Plug Cat. #	EEMAC Config.
15 amp, 125 volt	Dead End	1/2	ENR11151	ENR12151	ENR5151		ENP5151	
		3/4	ENR21151	ENR22151				
		1	ENR31151	ENR32151				
	Through Feed	1/2	ENRC11151	ENRC12151				
		3/4	ENRC21151	ENRC22151				
		1	ENRC31151	ENRC32151				
15 amp, 250 volt	Dead End	1/2	ENR11152	ENR12152	ENR6152		ENP6152	
		3/4	ENR21152	ENR22152				
		1	ENR31152	ENR32152				
	Through Feed	1/2	ENRC11152	ENRC12152				
		3/4	ENRC21152	ENRC22152				
		1	ENRC31152	ENRC32152				
20 amp, 125 volt	Dead End	1/2	ENR11201	ENR12201	ENR5201		ENP5201	
		3/4	ENR21201	ENR22201				
		1	ENR31201	ENR32201				
	Through Feed	1/2	ENRC11201	ENRC12201				
		3/4	ENRC21201	ENRC22201				
		1	ENRC31201	ENRC32201				
20 amp, 250 volt	Dead End	1/2	ENR11202	ENR12202	ENR6202		ENP6202	
		3/4	ENR21202	ENR22202				
		1	ENR31202	ENR32202				
	Through Feed	1/2	ENRC11202	ENRC12202				
		3/4	ENRC21202	ENRC22202				
		1	ENRC31202	ENRC32202				

\* Single gang receptacle units can be modified for Class 1, Group B usage. Add suffix B to the Cat. No. Example: ENRB11201. Seals must be installed immediately adjacent to each conduit opening.

‡ 15A With Copper-free aluminum EDS, EDSC back boxes.  
20A with Feraloy® iron alloy EDS, EDSC back boxes